

BOMANN®

HOUSEHOLD- TABLE DISHWASHER TSG 708



Instruction Manual

CE

Contents

Introduction.....	Page 3
General Notes.....	Page 3
Special safety Information for this Unit.....	Page 4
Unpacking the Appliance.....	Page 5
Overview of the Appliance.....	Page 5
Installation.....	Page 5
Prior Using for the first Time.....	Page 7
Loading the Dishwasher Basket.....	Page 9
Starting a Rinse Program.....	Page 11
Cleaning and Maintenance.....	Page 13
Troubleshooting.....	Page 15
Technical Data.....	Page 17
Disposal.....	Page 19

Introduction

Thank you for choosing our product. We hope you will enjoy using the appliance.

Symbols in these Instructions for Use

Important information for your safety is specially marked. It is essential to comply with these instructions in order to avoid accidents and prevent damage to the machine:

WARNING:

This warns you of dangers to your health and indicates possible injury risks.

CAUTION:

This refers to possible hazards to the machine or other objects.

 **NOTE:** This highlights tips and information.

General Notes

Read the operating instructions carefully before putting the appliance into operation and keep the instructions including the warranty and the receipt. If you give this device to other people, please also pass on the operating instructions.

 **NOTE:** The illustrations in this instruction manual can deviate from the original appliance.

- The appliance is designed exclusively for private use and for the envisaged purpose. This appliance is not fit for commercial use.
- The appliance is only to be used as described in the user manual. Do not use the appliance for any other purpose. Any other use is not intended and can result in damages or personal injuries.
- Do not use it outdoors. Keep it away from sources of heat, direct sunlight and humidity.
- Do not operate the appliance **without** supervision.
- When not in use, for cleaning, user maintenance works or with disruption, switch off the appliance and disconnect the plug (pull the plug itself, not the lead) or turn off the fuse.
- The appliance and if possible the mains lead have to be checked regularly for signs of damage. If damage is found the appliance must not be used.
- For safety reasons, alterations or modifications of the appliance are prohibited.
- In order to ensure your children's safety, please keep all packaging (plastic bags, boxes, polystyrene etc.) out of their reach.

WARNING:

Do not allow small children to play with the foil. There is a **danger of suffocation!**

Special safety Information for this Unit

- The maximum number of place settings to be washed is 6.
- This unit is intended to be used in household and similar applications such as
 - staff kitchen areas in shops, offices and other working environments;
 - by clients in hotels, motels and other residential type environments;
 - in farm houses.
- The appliance is to be connected to the water mains using new hose sets and that old hose-sets should not be reused.
- The maximum permissible inlet water pressure is 1 Mpa.
- The minimum permissible inlet water pressure is 0.04 Mpa.
- In the appliance bottom are located ventilation openings (depending on model). These may not be clogged e.g. by carpet.
- Open the door carefully during operation, there is a risk of water squirting out.
- Pay attention to a proper loading of the appliance. Follow the instructions in the chapter "Loading the Dishwasher Basket".
- Knives and other utensils with sharp points must be loaded with their points down in the cutlery basket or placed in a horizontal position in the dishwasher.
- Do not abuse, sit on, or stand on the opened door or dish rack. Do not place any heavy objects on the door.
- The door should not be left open, since this could increase the risk of tripping.
- This appliance can be used by **children** aged from 8 years and above and persons with reduced physical, sensory or mental capabilities or lack of experience and knowledge if they have been given supervision or instruction concerning **use of the appliance** in a safe way and understand the hazards involved.
- **Children** who are younger than 8 years must be kept away from the device.
- **Children** shall not play with the appliance.
- Cleaning and **user maintenance** shall not be made by **children**, unless they are older than 8 years and are supervised.

- Do not try to repair the appliance on your own. Always contact an authorized technician. If the supply cord is damaged, it must be replaced by the manufacturer, its service agent or similarly qualified persons in order to avoid a hazard.

Unpacking the Appliance

1. Remove the appliance from its packaging.
2. Remove all packaging material, such as foils, filler and cardboard packaging.
3. To prevent hazards, check the appliance for any transport damage.
4. In case of damage, do not put the appliance into operation. Contact your distributor.

i NOTE:

Production residue or dust may have collected on the appliance. We recommend cleaning the appliance according to chapter "Cleaning and Maintenance".

Overview of the Appliance

Appliance features

Front view

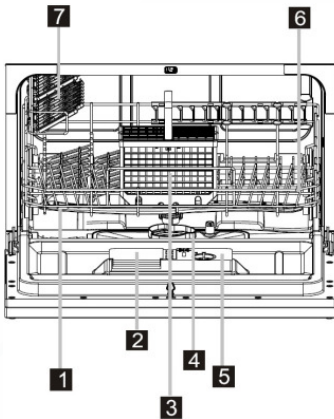

Back view

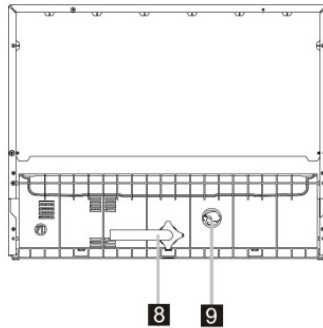

1	Spray arm
2	Detergent dispenser
3	Cutlery basket
4	Filtersystem
5	Rinse aid dispenser
6	Dishwasher basket
7	Cub shelves
8	Connection for inlet hose
9	Connection for drain hose

Delivery scope

Cutlery basket, cub shelf (2 pcs), funnel tube, inlet hose

Installation

⚠ WARNING:

The unit must not be connected to the mains during installing. Otherwise there is **danger to life** or **electric shock hazard!**

△ CAUTION:

For a correct operation the appliance must be connected properly. The specifications for water supply and drain as well as the electrical connection must fulfill the required criteria.

Installation location

- The site should be located near water inlet and outlet, as well as near a properly grounded power socket.
- Take care of a solid and horizontal position of the appliance.
- Power cable and water hoses may not kinked or squashed.
- **Avoid the installation:**
 - near heaters, next to a stove, direct sunlight or any other heat sources;
 - at locations with high humidity (e.g. outdoors), as metal parts would be susceptible to corrosion under such circumstances;
 - in rooms where the temperature could drop below freezing. Do not expose the appliance any weather.
 - near volatile or flammable materials (e.g. gas, fuel, alcohol, paint, etc.).

Water connection**△ CAUTION:**

- The Installation of the water supply must conform to the local laws and regulations.
- Use the new supplied hose set to connect the appliance to the water supply. Do not reuse old or used connection sets.
- If the water pipe is new or long time not used, ensure before connecting to the water system, that the water is clear and free from contamination.

Notes on inlet hose safety system (not included in delivery)

The safety system consists of a double-walled inlet hose. This system guarantees to cut off the water supply when leakage of the inner hose. Switching off the water supply leads over an electronic contact.

If necessary, you can order an inlet hose safety system from your dealer or in our online accessories shop, www.bomann.de. To order, use the reference number found under "Technical Data".

Connect the water inlet hose (cold water connection)**i NOTE:**

The water pressure must be between 0.04 and 1 MPa. With higher pressure: use a pressure regulator.



- Connect the water inlet hose to a cold water thread with $\frac{3}{4}$ ". Screw the hose firmly in the direction of the screw thread; pay attention for a tight fit.
- Connect the other end of the inlet hose to the inlet valve on the appliance back; pay attention for a tight fit too.

Hot water supply

The dishwasher can be supplied with a water temperature of not more than 60°C. Supplying the appliance with hot water, the rinse running time is shortened but the cleaning effect can be slightly reduced. The connection to the hot water valve must be done in the same manner as described for the cold water connection.

Connect the water drain hose

NOTE:

The drain hose has a length of approx. 1.5 m and can extend with a suitable hose and connecting piece to a length of max. 4 m.

CAUTION:

In order to prevent backflow of contaminated water, the free end of the hose must not come under the water level of the drain.

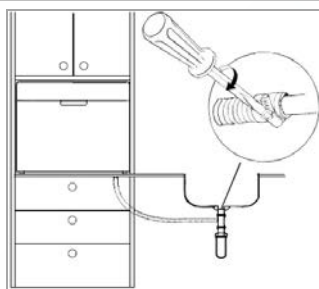
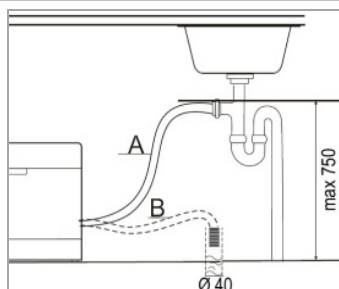

- Connect the drain hose to a drain pipe with a minimum diameter of 40 mm; alternatively the drain hose can be fixed directly to the sink.
- Always make sure that the hose is not bent or squeezed.

- It is allowed to install the hose maximal at a height of 750 mm to the appliance base.
- Secure the hose securely in order to avoid a change in position and with it a water leakage.

Electrical connection

WARNING:

- The installation to the mains supply must conform to the local standards and regulations.
- Improper connection may cause to an **electric shock!**
- Do not use multiple sockets or extension cords.
- It is not allowed to modify the plug provided with the appliance. If the plug does not fit properly to the outlet, let install a proper outlet by an authorized specialist.
- The accessibility of the power plug must always be ensured in order to disconnect the device from the power supply in case of an emergency.
- Ensure that your mains power corresponds with the specifications of the appliance. The specifications are printed on the rating label.
- Connect the mains cable to a properly installed and earthed wall outlet.
- If the plug after installation is not accessible, an all-pole disconnect device with a contact separation of at least 3 mm must be available to meet the relevant safety regulations.

Prior Using for the first Time

Before using your dishwasher for the first time:

- Fill the rinse aid dispenser
- Fill in detergent

CAUTION:

- Use only rinse aid and detergent for dishwashers. Other products may damage the appliance.
- Always consider the dosage and storage recommendations on the sales packaging.

⚠ WARNING:

Keep rinse aid and detergent out of reach for children.

A. Fill the rinse aid dispenser**Function of rinse aid**

The rinse aid is automatically added during the final rinse, ensuring thorough rinsing and a spot and streak free drying.

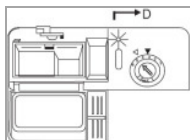
When to refill the rinse aid dispenser

As long as the rinse aid warning lamp does not light up on the control panel, you can estimate the amount of remaining rinse aid to the optical level indicator "D" next to the dispenser.

When the rinse aid dispenser is full, the indicator is completely dark. If the rinse aid diminishes, the size of the black dot changes as shown below. In order to avoid spotting, the rinse aid level must not drop below $\frac{1}{4}$.



full

 $\frac{3}{4}$ full $\frac{1}{2}$ full $\frac{1}{4}$ full – refill

empty

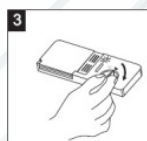
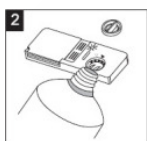
Fill in the rinse aid

1. To open the dispenser screw the lid counterclockwise to the open position (top arrow) and remove the lid.
2. Add the rinse aid into the dispenser; being careful not to overfill. The dispenser contains approx. 110 ml.
3. Put on the lid in the open position back and turn it clockwise to the closed position (right arrow).

NOTE:

- Remove during refilling spilled rinse aid with an absorbent cloth to avoid excessive foaming during the next rinse.
- Don't forget to replace the lid before closing the appliance door.

Adjusting the rinse aid dosage

When forming spots and the dishes dries poorly, increase the added amount of rinse aid. You can set the amount of addition between level 1 (min.) and level 6 (max.).



Take off the lid of the rinse aid dispenser and adjust the dial to the desired level. The factory setting is "4".

NOTE:

Increase the dosage if there are drops of water or lime spots on the dishes after rinsing. Reduce the dosage if there are sticky whitish stains on dishes or a bluish film on glassware or knife blades.

B. Fill in detergent

i NOTE:

The appliance is only suitable for the use of multi-functional tablets with an additional water softener (salt substitute), as it is not equipped with a water softener.

Function of detergent

Detergents with its chemical ingredients are necessary to remove dirt, crush dirt and transport it out of the dishwasher. The most commercially, high-quality cleaning agents are suitable for this purpose.

Detergent tablets (tabs)

Dishwasher tablets from different manufacturers dissolve at different rates. It is possible that they will not fully dissolve in programs with short running time and low water temperature and thus does not reach their full productive efficiency. To ensure the complete removal of detergent residues, we recommend to choose rinse programs with long running times and high water temperature. Always follow the manufacturer's instructions!

Detergent dispenser

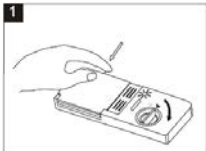

The dispenser must be refilled before the start of each rinse cycle according to the instructions in the "Rinse cycle table".

Press the release button to open the dispenser.

Notes for filling the detergent

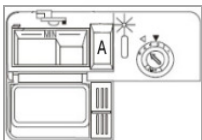

- Always add the detergent tablet just before starting the rinse cycle, otherwise it could get damp and will not dissolve properly.
- Put the detergent tab in the dispenser A or directly into the rinse container.
- At the end of the rinse cycle the detergent dispenser must be empty.

Loading the Dishwasher Basket

△ CAUTION:

Only rinse such dishes and cutlery in the dishwasher, which is expressly marked as "dishwasher resistant".

i NOTE:

- Remove gross scraps of food and soak burnt leftovers. Pre-rinse under running water is not necessary.
- Do not overload! This is important for adequate cleaning results and reasonable energy consumption.
- Very small items should not be rinsed in the appliance, as they could easily fall out of the basket.

For rinsing in the dishwasher the following cutlery and dishes..

..are not suitable:

- Cutlery with hand pieces of wood, porcelain mother of pearl
- Plastic items that are not heat resistant

..are limited suitable:

- Some types of glasses can become dull after a large number of washes
- Silver and aluminum parts have a tendency to discolor during washing

..are not suitable:

- Older cutlery with glued parts that are not temperature resistant
- Bonded cutlery items or dishes
- Pewter or cooper items
- Crystal glass
- Steel items subject to rusting
- Wooden platters
- Items made from synthetic fibres

..are limited suitable:

- Glazed patterns may fade if machine washed frequently

Recommendations for loading

- Make sure that the tableware is placed securely and cannot tip over.
- Place all items so, that the spray arm can rotate freely during rinsing.
- Arrange all items with openings facing down.
- Curved items, or ones with recesses, should be loaded aslant so that water can drain off.
- Make sure that glasses do not touch each other.
- Set the dishes and cutlery not into each other or covering each other.
- Arrange cutlery in the cutlery basket.
- Store long as well as sharp cutlery items horizontally in the dishwasher basket.

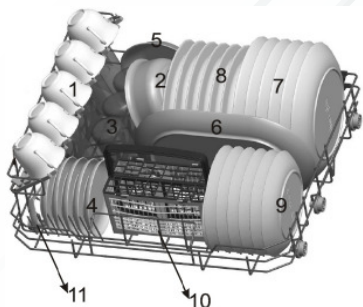
Method for loading standard dishes

1	Cups	5	Dish	9	Dessert dishes
2	Bowl	6	Oval platter	10	Cutlery basket
3	Glasses	7	Dinner plates	11	Serving cutlery
4	Saucers	8	Soup plates	-	

Cutlery basket**⚠ WARNING: Risk of injury!**

- Cutlery must not protrude above the cutlery basket base.
- Knives and other utensils with sharp points must be placed with the tip down in the cutlery basket or in a horizontal position in the dishwasher basket.

ℹ NOTE:

If necessary, remove the basket in order to create more space for large dishware.

The basket is equipped with mesh inserts in which the cutlery is arranged uniformly and with the handles at the bottom. In the basket all types of cutlery can be arranged, except of very long items, which must be placed in the dishwasher basket, as pictured.

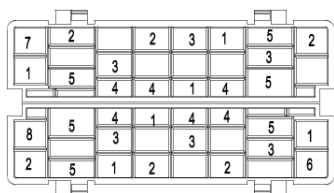





1	Forks	5	Knives
2	Soup spoons	6	Serving spoons
3	Dessert spoons	7	Gravy ladies
4	Teaspoons	8	Serving forks

Starting a Rinse Program

Rinse cycle table

Select a suitable program depending on dishes and degree of soiling.

Program	Program selection information	Program sequence	Detergent tablet	Time (Min.)	Energy (kWh)	Water (L)	Rinse aid
 Intensive	heavily soiled dishes, dried leftovers	Pre-rinse (50°C) Main rinse (70°C) Rinse 1 Rinse 2 Rinse 3 (70°C) Drying	1 piece	140	0.9	10	★
 Normal	normally soiled dishes, daily use	Pre-rinse Main rinse (60°C) Rinse 1 Rinse 2 (70°C) Drying	1 piece	120	0.7	8	★
ECO (*EN 50242)	Standard program for normally soiled dishes	Pre-rinse Main rinse (50°C) Rinse 1 Rinse 2 (70°C) Drying	1 piece	180	0.61	6.5	★
 90 Min	lightly soiled crockery, glass	Main rinse (65°C) Rinse (70°C) Drying	1 piece	90	0.65	7	★
 Pre-rinse (soak)	for dishes, that will be rinsed later that day	Rinse		15	0.01	2.2	

NOTE:

- We recommend the use of multi-tabs with additional water softener. Always follow the manufacturer's instructions on the sales packaging and consider the information that we give you under "B: Fill in detergent".
- ★ Using extra rinse aid can possibly improve the drying efficiency.
- *EN 50242: this is the test program and of combined energy and water consumption most efficient.
The information for comparability: -Capacity: 6 settings; -Rinse aid setting: 6

Control panel

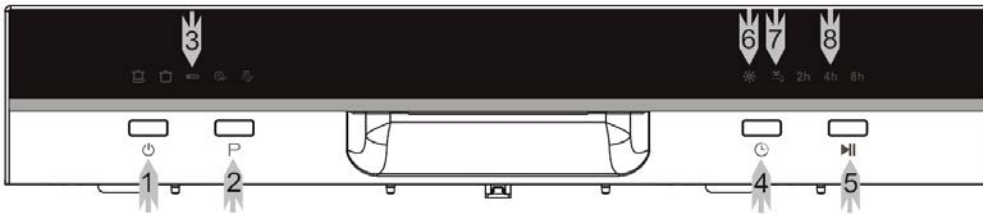

1. Power button to switch on or off the power supply.
2. Program selection button to select one of six rinse programs. By repeatedly pressing this button, you can select the rinse program.
3. The corresponding program control lamp indicates the selection of the rinse program.
4. By repeatedly pressing this button, you can select a start delay time of 2, 4, 6 or 8 hours.
 1 x press = 2h 2 x press = 4h 3 x press = 6h 4 x press = 8h 5 x press = delete
 Choose the wanted program and press the start/pause button. The operation will start automatically after the selected lead time has elapsed.
5. Start/pause button to start or pause the selected or running rinse program.
 program control lamp is flashing: operation program control lamp is lighting: pause/standby
6. Rinse aid warning lamp, lights up when the rinse aid dispenser needs to be refilled.
7. The control lamp indicates the activated water supply.
8. The corresponding control lamp indicates the selection of the start delay.
 NOTE: When setting 6h, the lamps 2h and 4h lights at the same time.

Starting a rinse program

- The water supply must be opened up to the maximum pressure.
- Load the dishwasher basket.
- Fill in the detergent.
- Close the appliance door and press the power button to switch on the appliance.
- Select the desired rinse cycle.
- Set the available options, if required.
- Press the start/pause button and the dishwasher starts.

Program change

⚠ CAUTION:

A program change should be done only a short time after starting the program. Otherwise, maybe detergent has been released and already drained rinse water.

- To do a program change, press the start/pause button. Then press the program selection button for several seconds. The appliance is in standby mode.
- Select the desired program and press the start/pause button to start the new operation.

Forgot to add a dish?

WARNING:

Open the door very carefully during operation, there is a risk of water squirting out.

Dishware can be added any time before the detergent dispenser opens.

- Press the start/pause button.
- Open the door carefully a little.
- Once the spray arm stopped working, you can open the door completely.
- Add forgotten dishware.
- Close the door.
- Press the start/pause button, after approx. 10 seconds the operation will be continued.

At the end of program

CAUTION:

Allow the appliance to cool down a bit after the program has ended, before you open it. This avoids that steam escapes that causing long-term damages to your furniture.

At the end of the rinse cycle will sound a series of signals; then the unit goes into standby mode.

After about 30 minutes without operation, the appliance switches off automatically.

Switch off

- Switch off the appliance by pressing the power button.
- Close the water supply!
- Remove the dishes after cooling (see "Unloading the dishwasher basket").
- If the appliance is not in use for an extended period:
 - Disconnect the mains plug or switch off or turn out the fuse and
 - Leave the appliance door slightly open until the next rinse cycle to avoid odors.

Unloading the dishwasher basket

CAUTION:

Let the dishware cool down for about 15 minutes before unloading. Hot dishes are sensitive to knocks.

NOTE:

At the end of program there could be still water drops inside the appliance.

Open the appliance door and pull out the basket for unloading.

Cleaning and Maintenance

WARNING:

- Always switch off the appliance and disconnect the plug or turn off / unscrew the fuse before cleaning and user maintenance.
- Allow the appliance to cool down sufficient before cleaning.
- Do not use steam cleaners for cleaning the appliance; moisture could enter electrical components. **Risk of electric shock!** Hot steam could damage the plastic parts. The appliance must be dry before restarting.

△ CAUTION:

- Do not use a wire brush or other sharp, abrasive items.
- Do not use any acidic or abrasive detergents.

ℹ NOTE:

Dirty filters and clogged spray arms degrade the rinsing. Regularly check the filter and spray arm and clean them if necessary.

Filter system

The three-part filter system prevents larger amounts of food or other objects from getting inside the pump.

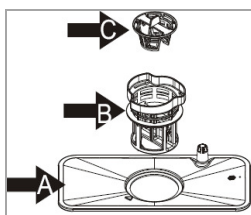

A. Main filter: food and soil particles trapped in this filter are pulverized by a special jet on the spray arm and washed down to drain.

B. Micro filter: filters dirt and food residues in the sump area and prevents it from being redeposited on the dishware during rinse cycle.

C. Coarse filter: filters out larger items such as pieces of bone or glass shards that could block the drainage.

Cleaning the filter system**△ CAUTION:**

- The dishwasher must never be used without the filter.
- Improper replacement of the filter can reduce performance and damage the appliance.
- Do not knock out the filter for cleaning to avoid possible deformations of the filters.

ℹ NOTE:

Check after each rinsing the filter for residues.

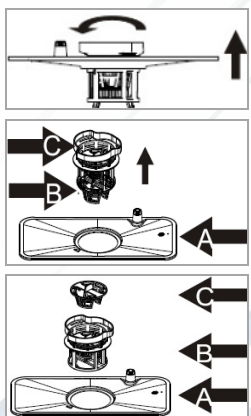

- Turn the filter unit (coarse/micro filter) counterclockwise and remove the whole filter system upwards.
- Remove the filter unit from the main filter. Loosen the coarse filter from the micro filter, by pushing it from below side.
- Remove leftover food and clean the filters under running water. Use a soft brush, if necessary.
- Put the filter system properly in reverse order together and reinstall in its provided position. Fix the entire system, by tightening the filter unit clockwise.

Cleaning the spray arm

Lime and impurities from the rinsing water can block nozzles and bearings of the spray arm. Check the outlet nozzles of the spray arm regularly for blockages.

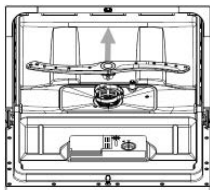

- Pull off the spray arm upwards.
- Clean the spray arm under running water; if necessary use a soft brush for the nozzles.
- Insert the spray arm again until it clicks into place.

Maintenance of the dishwasher

⚠ CAUTION:

Never use spray cleaners to clean the door panel, this may damage the door lock and electrical components.

- Clean the appliance outer surfaces thoroughly with a soft, damp cloth. Use only mild cleaning agent.
- Use to remove stains inside the appliance a dampened cloth with a little white vinegar or a special detergent for dishwashers. If necessary, fill detergent in and start the appliance without dishware in the program with the highest rinse temperature.
- Dry the outer surfaces thoroughly before taking in operation again.

Antifreeze protection

If the device is out of operation and exposed to temperatures below zero, observe the following precautions:

- Disconnect the mains plug.
- Close the water supply and remove the inlet hose from the water valve.
- Drain the water from the inlet hose and the water valve.
- Reconnect the inlet hose to the water valve.
- Take off the filter system. Remove the remaining water in the sump with a sponge.

Energy saving Tips

- Always try to operate the dishwasher when it is fully loaded.
- Do not rinse the dishes in advance under running water.
- Use for each type of load the most appropriate rinse program.
- Do not perform a pre-rinse (depending on model), if not absolutely necessary.
- If available, the appliance should be connected to a hot water supply up to 60°C.

Troubleshooting

Before you contact an authorized specialist

Problem	Possible causes	What do to
The appliance is not working	Fuse blown or the circuit breaker acted	Replace fuse or reset circuit breaker. Remove any other units sharing the same circuit with the dishwasher.
	Power supply is not turned on	Insert the power plug properly. Make sure the appliance is switched on and the door is closed securely.
	Water pressure is low	Check if the water supply is connected properly and the water is turned on.

Problem	Possible causes	What do to
Water is not drained off	Kink in drain hose	Check the drain hose.
	Filter clogged	Check the filter system.
	Kitchen sink clogged	Check kitchen sink to make sure it is draining well. If the kitchen sink is clogged, you may need a specialist.
Noise	Some audible sounds are normal	E.g. sound from detergent dispenser opening.
	Dishware is not secured	Take care that the dishware is secured in the dishwasher.
	The spray arm knocks against a piece of tableware	Place the parts so that the spray arm can rotate freely during rinsing.
Suds in the tub	Improper detergent	Use only special dishwasher detergent to avoid suds. If this occurs, open the door and let suds evaporate. Add approx 4 liter cold water to the tub. Close the door and start a short rinse cycle to drain out the water.
	Spilled rinse agent	Always wipe up rinse agent spills immediately.
Stained tub interior	Detergent with colorant was used	Only use detergent without colorant.
Dishes and flatware not clean	Improper program	Select a stronger program.
	Improper basket loading	Make sure that the action of the detergent dispenser and spray arm are not blocked by large dishes.
Spots and filming on glasses and flatware	<ul style="list-style-type: none"> - Extremely hard water - Low inlet temperature - Overloading the baskets - Improper loading - Old or damp detergent - Empty rinse dispenser - Incorrect dosage of detergent 	<p>To remove spots of glassware:</p> <ul style="list-style-type: none"> - Take out all metal utensils of the appliance. - Do not add detergent. - Select a longer rinse cycle. - Start the dishwasher and allow it to run for about 15 minutes up to the main rinse. - Open the door and pour 2 cups of white vinegar into the bottom of the dishwasher. - Close the door and let complete the rinse cycle. If the vinegar does not work: repeat as above, except use ¼ cup (60 ml) of citric acid crystals instead of vinegar.
Cloudiness on glassware	Combination of soft water and too much detergent	Use less detergent if you have soft water and select a shortest cycle to rinse glassware and to get clean.
Yellow or brown film on inside surface	Tea or coffee stains	Using a solution of ½ cup of bleach and 3 cups of warm water to remove the stains by hand.
	Iron deposits in water can cause an overall film	Call a water softener company for a special filter.
White film on inside surface	Hard water minerals	To clean the interior, use a damp sponge with dishwasher detergent. Wear rubber gloves.
Detergent dispenser close not properly	Clogged detergent residue is blocking the catch	Clean the detergent from the catch.

Problem	Possible causes	What do to
Detergent left in dispenser	Dishes blocks the dispenser	Reload the dishes.
Steam	Normal	There is some steam coming through the vent by the door latch during drying and water draining.
Black or grey marks on dishware	Aluminum utensils have rubbed against dishware	Use a mild abrasive cleaner to eliminate those marks.
Water standing on the bottom of the tub	Normal	A small amount of clean water around the outlet on the tub bottom keeps the water seal lubricated.
Dishwasher leaks	Overfill dispenser or rinse aid spills	Do not overfill the dispenser. Spilled rinse aid could cause oversudsing and lead to overflowing.

Error codes

With some malfunctions the appliance displays the following error codes to warn you:

Prog. control lamp	Meaning	Possible cause
Pre-rinse flicker fleetly	Longer inlet time	The water tap is not opened, the water supply is not free or the water pressure is too low.
Eco flicker fleetly	Overflow	Some element of dishwasher leaks.

⚠ CAUTION:

- If overflow occurs, turn off the main water supply before calling an authorized technician.
- If there is water in the lower housing part due to an overfilling or a small leak, remove this water before restarting the appliance.

ℹ NOTE:

If a problem still persists after following the steps above, contact your distributor or an authorized technician.

Technical Data

Measures / Weights		
Height x Width x Depth (depth with open door)	cm	43.8 x 55.0 x 50.0 (81.2)
Net weight	kg	20.5
Electrical connection		
Connection power	W	1280
Connection voltage	V~ / Hz	230 / 50
Fuse protection	A	10
Water protection	Mpa (bar)	0.04 – 1.0 (0.4-10)
Accessory		
Inlet hose safety system (not included)	Art.-No.	8900 400

The right to make technical and design modifications in the course of continuous product development remains reserved.

Product data sheet for household dishwasher according to regulation (EU) No. 1059/2010

Brand		Bomann
Model		TSG 708
Standard place settings		6
Energy efficiency class ¹⁾		A+
Annual energy consumption ²⁾	kWh	174
Energy consumption of the standard cleaning cycle	kWh	0.61
Power consumption of the off mode	W	0.45
Power consumption of the left-on mode	W	0.49
Weighted annual water consumption ³⁾	l	1820
Drying efficiency class ⁴⁾		A
Standard program to which the information relates to the label and the data sheet ⁵⁾		ECO 50°C
Program duration of the standard cleaning cycle	Min.	180
Duration of the left-on mode	Min.	30
Noise emission	dB(A) re1pW	51
Built-in appliance		-

1) A+++ (highest efficiency) to D (lowest efficiency).

2) Based on 280 standard cleaning cycles using cold water fill and the consumption of the low power models. Actual energy consumption will depend on how the appliance is used.

3) Based on 280 standard cleaning cycles. Actual water consumption will depend on how the appliance is used.

4) A (highest efficiency) to G (lowest efficiency).

5) This program is suitable for cleaning normally soiled tableware and that it is the most efficient program in terms of its combined energy and water consumption for that type of tableware.

Note: The above values have been measured in accordance with standards under specified operating conditions. Results may vary greatly according to quantity and pollution of the dishes, water hardness, amount of detergent, etc.

This appliance has been tested according to all relevant current CE guidelines, such as electromagnetic compatibility and low voltage directives, and has been constructed in accordance with the latest safety regulations



Disposal

Meaning of the “Dustbin” Symbol

Protect our environment; do not dispose of electrical equipment in the domestic waste.

Please return any electrical equipment that you will no longer use to the collection points provided for their disposal.

This helps avoid the potential effects of incorrect disposal on the environment and human health.

This will contribute to the recycling and other forms of reutilization of electrical and electronic equipment.

Information concerning where the equipment can be disposed of can be obtained from your local authority.

⚠ WARNING:

Remove or disable any existing snap and bolt locks, if you take the appliance out of operation or dispose it.



BOMANN®

C. Bomann GmbH

www.bomann.de

Made in P.R.C.

Stand 12/16